

Hafa[®]

East 600/900/1200

Art.nr 1542170, 1542171, 1542172

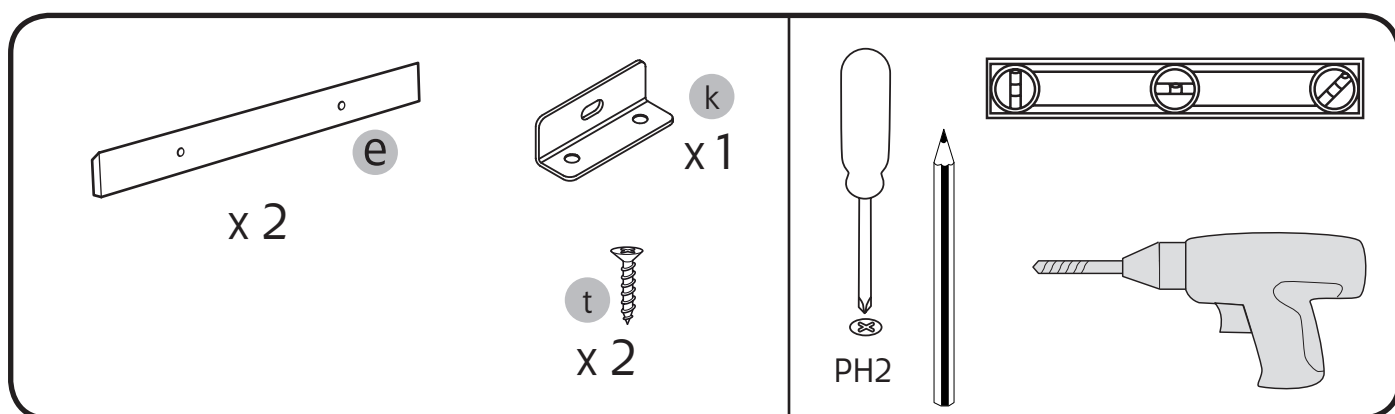
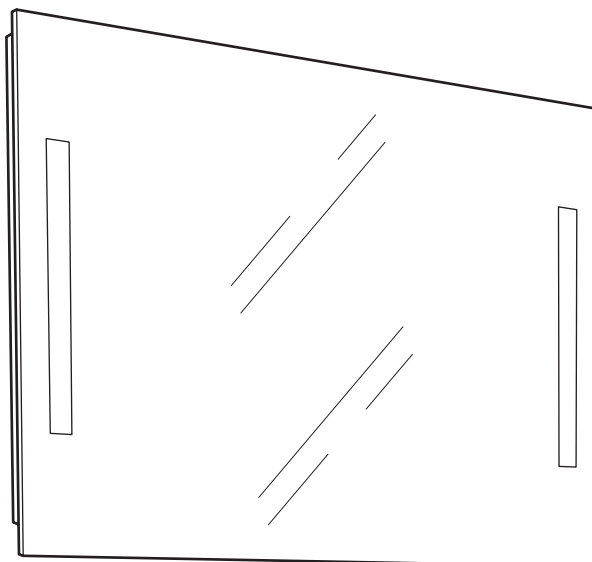

Hafa[®]

Hafa
Svarvaregatan 5, Box 525
SE-301 80 Halmstad
SWEDEN

Garanti/Warranty.
Service, reservdelar/spare parts
Sweden: Tel: +46 (0)35 15 44 75
Norway: Tel: +47 (0)69 31 02 30
Finland: Puh: +358 (0)9 61500940

www.hafa.se
www.hafa.dk
www.hafabad.no
www.hafa.se
www.hafabathroom.ru
www.hafa.eu

E-mail:
service@hafa.se
service@hafabad.no

1

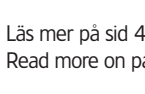
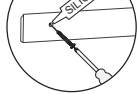
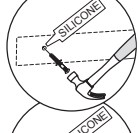
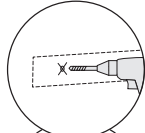
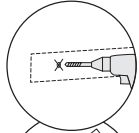
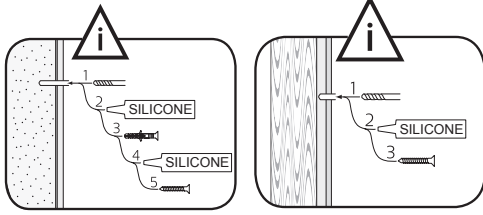

Läs mer på sid 4
Read more on page 4

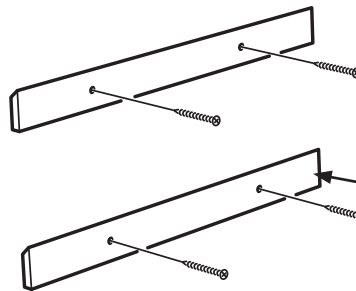

2 x

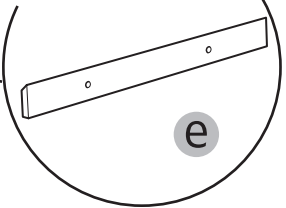

e



OBS! Använd skruv som passar ditt väggmaterial
OBS! Brug den skrue, der passer til dine væggmaterialer
OBS! Bruk skruer som passer til veggmaterialet
HUOM! Käytä seinämateriaaliin sopivaa ruuvia
NOTE! Use screws suitable for your wall material

2

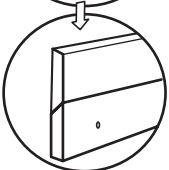
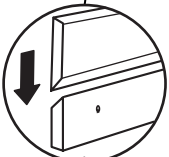
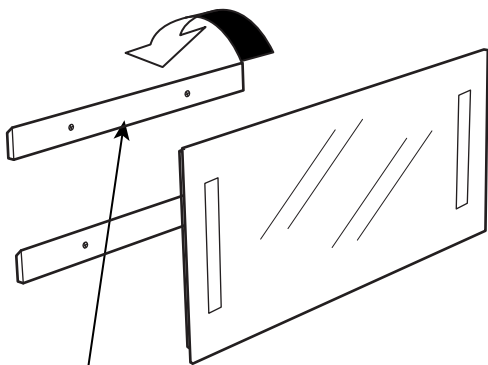

3

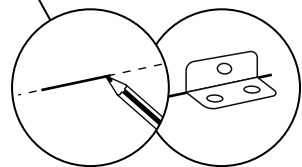
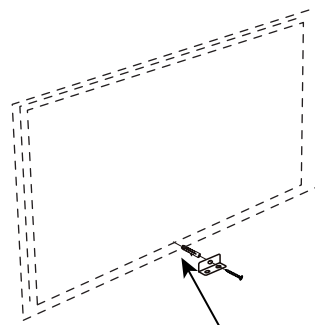

1 x

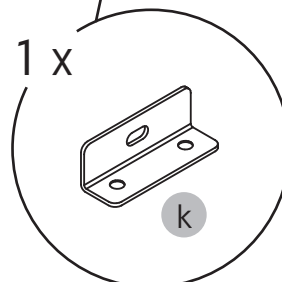

k

4

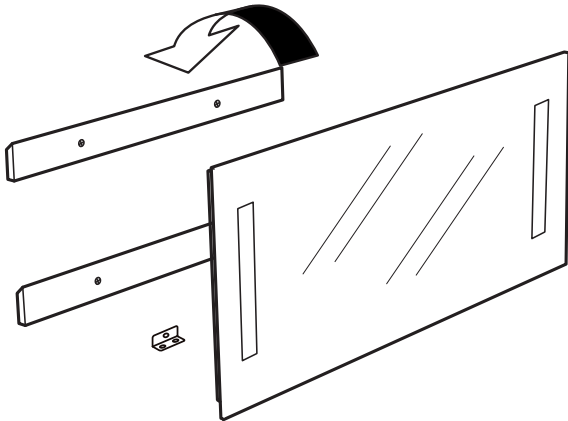
**230 V**

OBS! Endast behörig elektriker
OBS! Må bare monteres av autorisert elektriker
OBS! Skal tilsluttes af autoriseret elektriker
HUOM! Vain asianmukainen sähkömiehes
NOTE! Authorized personnel only

5

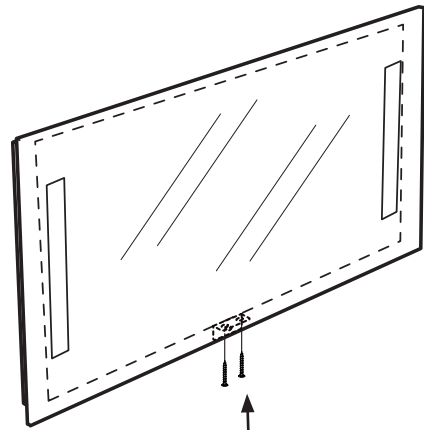

2 x

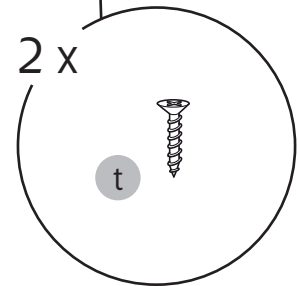

i

Byta lysrör T5 2x8 W
 Bytte av lysrör T5 2x8 W
 Udskitning lysrör T5 2x8 W
 Vaihtaa loisteputki T5 2x8 W
 Change light tubes T5 2X8 W

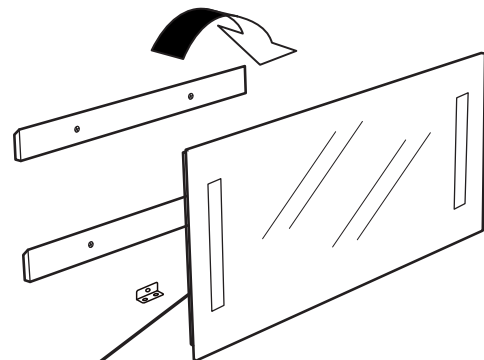
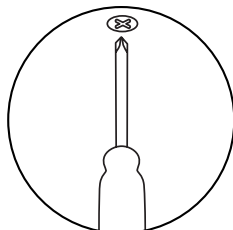
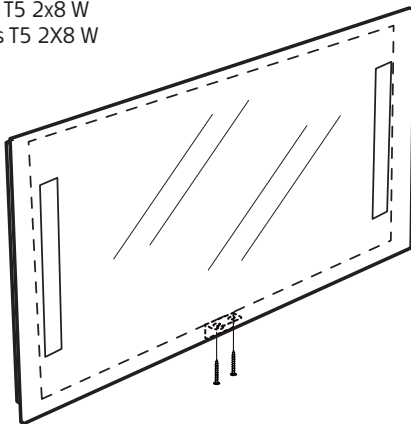

2 x

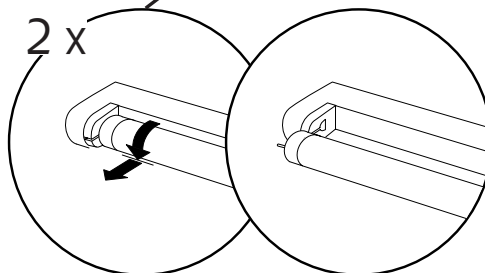

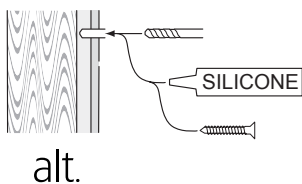

SE

Skruvfästningar i våtzon 1 ska göras i betong eller annan massiv konstruktion, träreglar, träkortlingar eller i konstruktion som är provad och godkänd för infästning, till exempel skivkonstruktion. Se exempel på godkända konstruktioner på sakervatten.se. Krav på tätning gäller både i våtzon 1 och 2. Material för tätning ska fästa mot underlaget och vara vattenbeständigt, mögelresistent och åldersbeständigt.

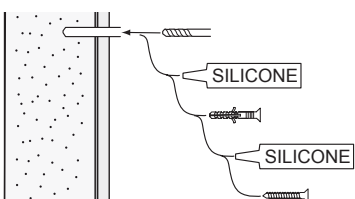

GB

Below are Swedish recommendations:

Screw fastenings should be made in concrete or other solid structure, wooden studs, wooden noggings or in structures that have been tested and approved for fastenings, for example a sheet construction. Requirements for sealing apply in wet zones 1 and 2. See examples of construction at sakervatten.se. Sealing materials must be fixed to the underlying layer and must be waterproof, mould-resistant and age-resistant.

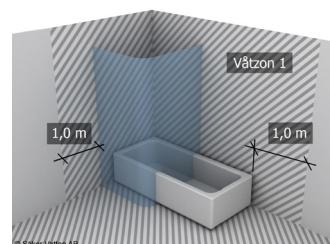

Hafa[®]

Hafa
Svarvaregatan 5, Box 525
SE-301 80 Halmstad
SWEDEN

Garanti/Warranty.
Service, resevdelar/spare-parts
Sweden: Tel: +46 (0)35 15 44 75
Norway: Tel: +47 69 31 02 30
Finland: Puh: 0207 43 50 00

www.hafa.se
www.hafa.dk
www.hafabad.no
www.hafa.se
www.hafabathroom.ru
www.hafa.eu

E-mail:
service@hafa.se
service@hafabad.no