

Hafa®

STORE SOFT/ SQUARE LED

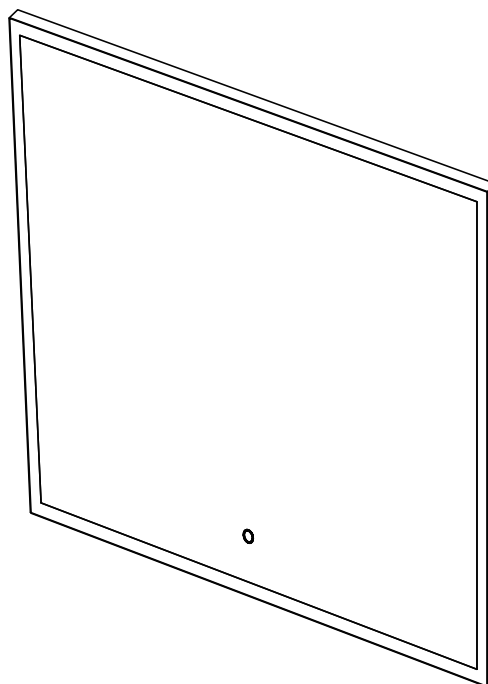
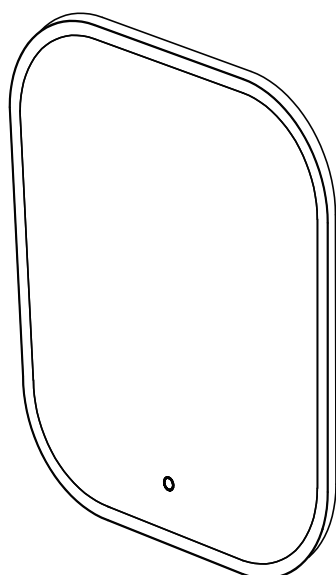
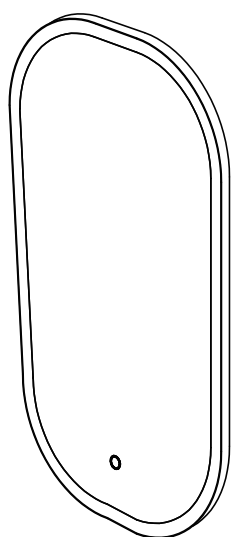

mm	400
Art.nr	1267230

mm	600
Art.nr	1267231

mm	420	600	800	900	1000	1200
Art.nr	1267223	1267224	1267225	1267226	1267227	1267228

CE IP44

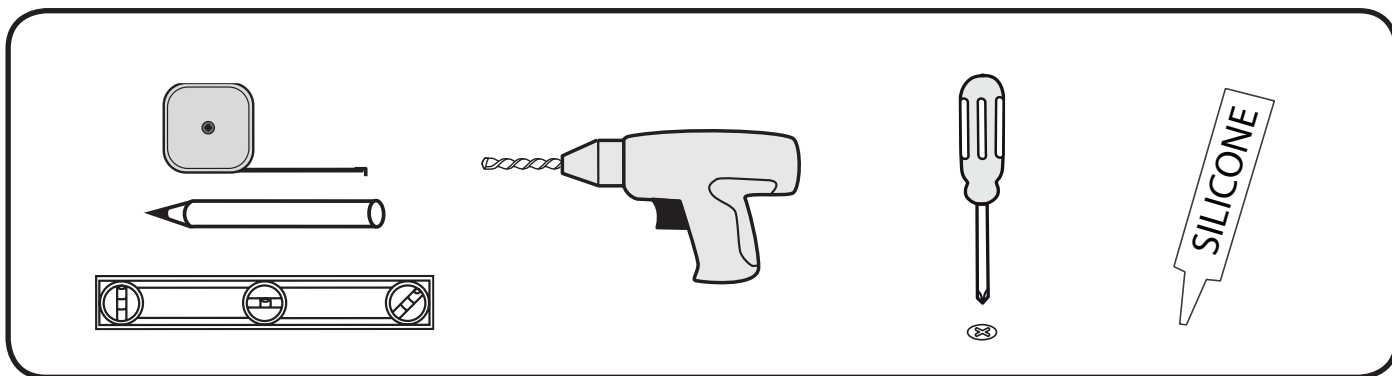

	<p>Hafa Svarvaregatan 5, Box 525 SE-301 80 Halmstad SWEDEN</p>	<p>Garanti/Warranty. Service, reservdelar/spare parts Sweden: Tel: +46 (0)35 15 44 75 Norway: Tel: +47 (0)69 31 02 30 Finland: Puh: +358 (0)9 61500940</p>	<p>www.hafa.se www.hafa.dk www.hafabad.no www.hafa.se www.hafabathroom.ru www.hafa.eu</p>	<p>E-mail: service@hafa.se service@hafabad.no</p>
--	--	--	---	---



SOFT

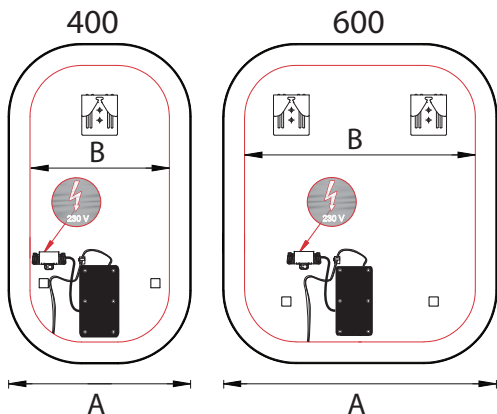

	400	420	600	800	900	1000	1200
A	400	420	600	800	900	1000	1200
B	304	324	504	704	804	904	1104
C	--	120	300	450	450	600	400x2
D	20	20	20	25	25	25	25
E	20	20	20	25	25	25	25
F	25	25	25	30	30	30	30

SQUARE

420/600

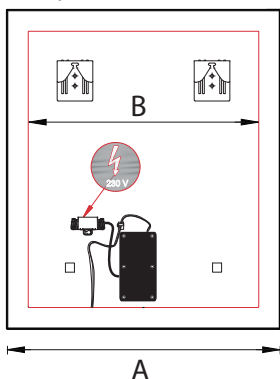

800/900/1000

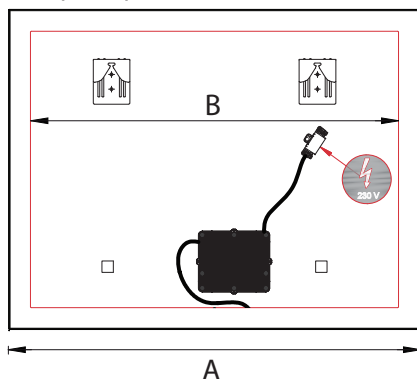

1200

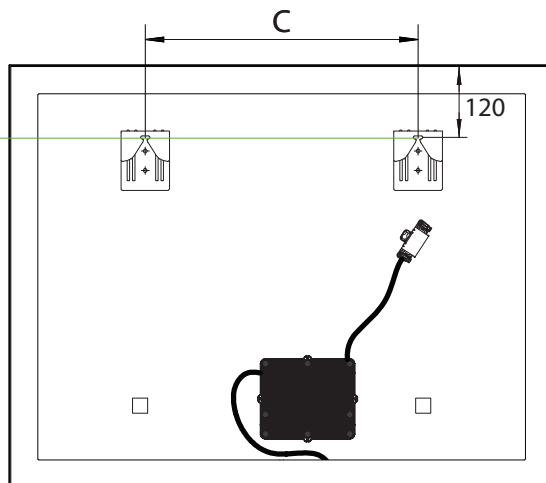
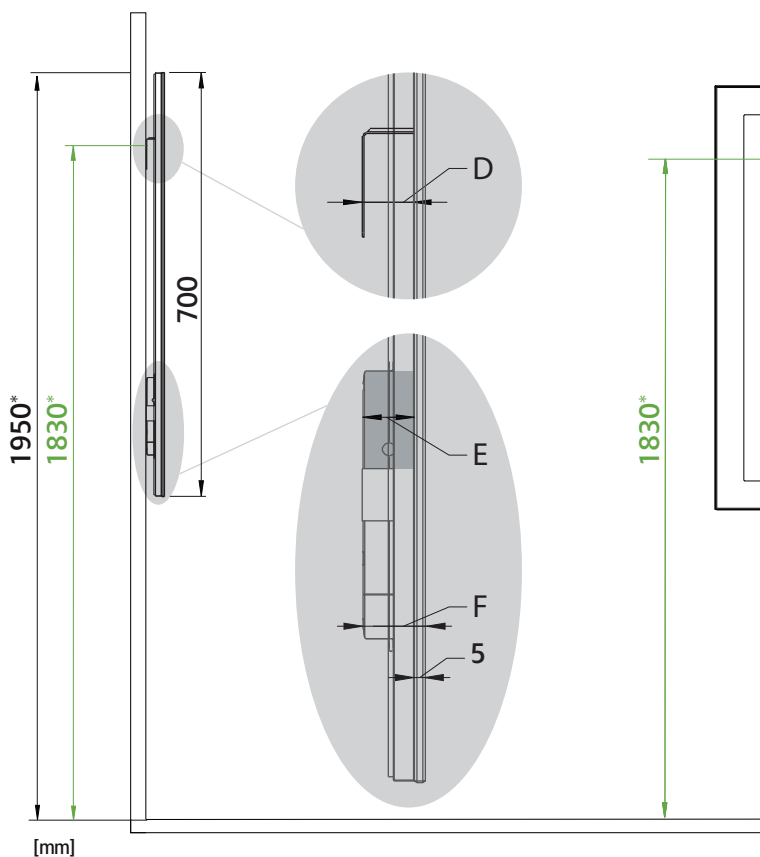
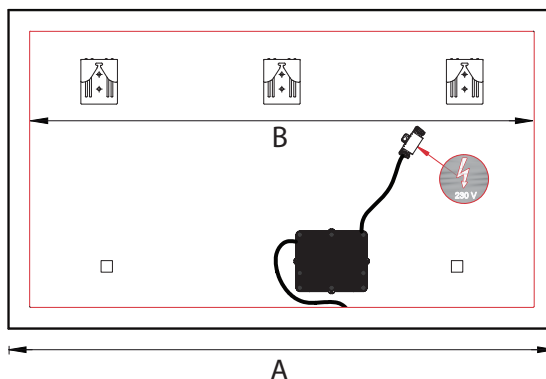

* SE Rekommendation NO Anbefale ENG Recommendation FI Suositus DK Anbefale

1

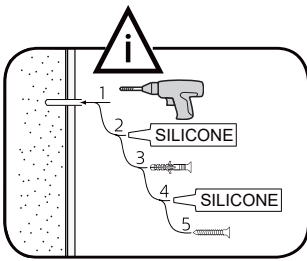

OBS! Använd skruv som passar ditt väggmaterial
OBS! Brug den skrue, der passer til dine væggmaterialer
OBS! Bruk skruer som passer til veggmaterialet
HUOM! Käytä seinämateriaaliin sopivaa ruuvia
NOTE! Use screws suitable for your wall material

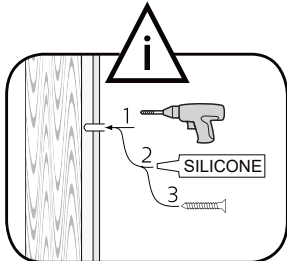

Läs mer på sid 4
 Read more on page 4

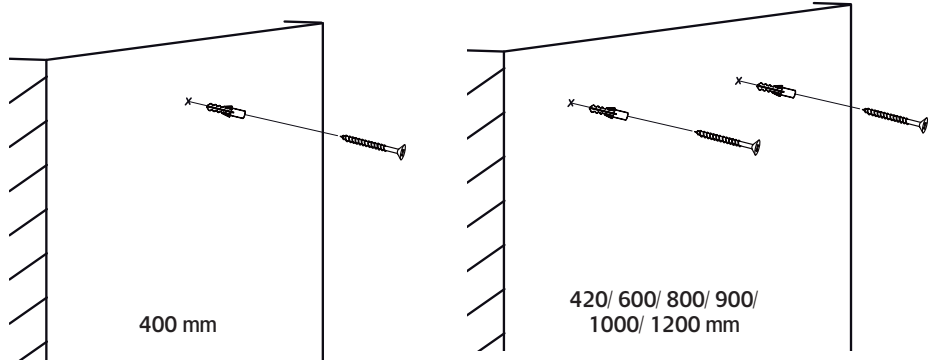

OBS! Borra aldrig hål i väggen utan att först ha kontrollerat mätten på det aktuella exemplaret.
OBS! Bor aldri hull i væggen uten å først kontrollere dimensjonene av den nåværende element.
OBS! Bor aldrig huller i væggen uden først at kontrollere dimensionerne af den nuværende vare.
HUOM! Ennen poraamista tarkistathan reikien mittasuhteet tuotteestasi.
NOTE! Before drilling any holes to the wall always check the position for the fixtures for the product itself.

2



230 V
OBS! Endast behörig elektriker
OBS! Må bare monteres av autorisert elektriker
OBS! Skal tilsluttes af autoriseret elektriker
HUOM! Vain asianmukainen sähkömies
NOTE! Authorized personnel only

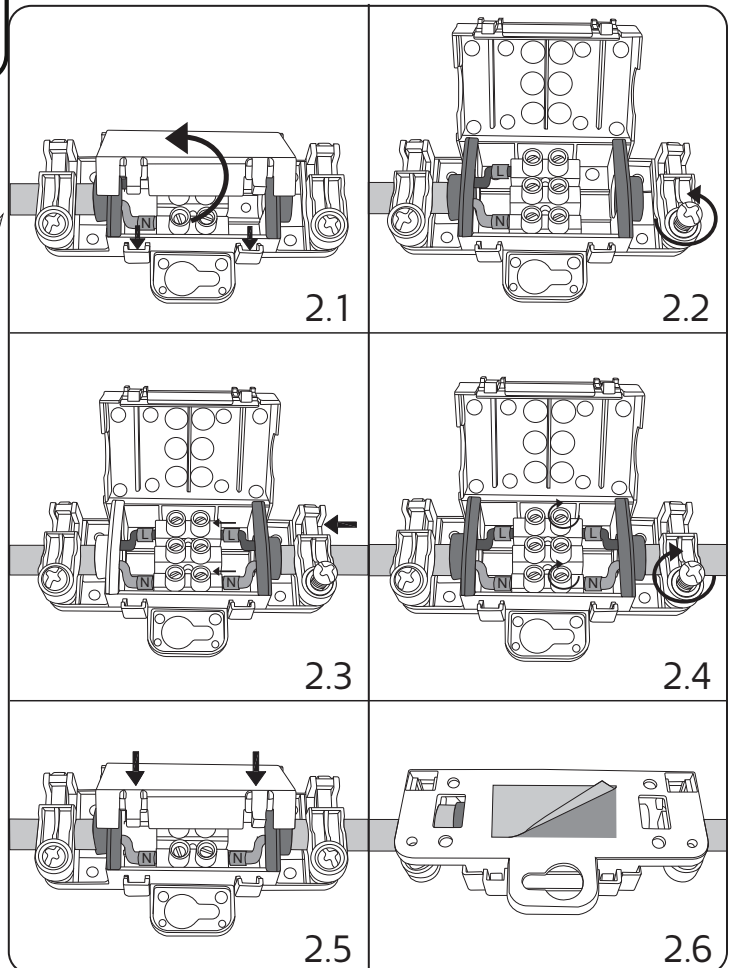
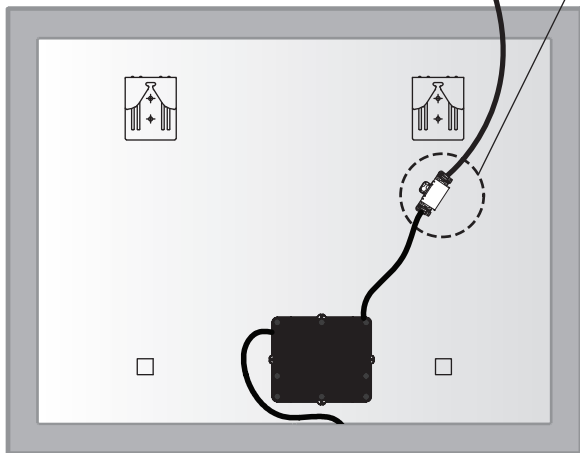

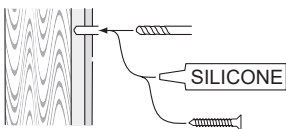
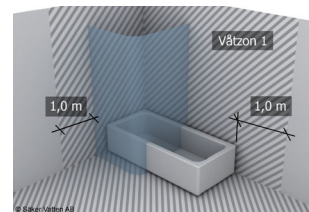
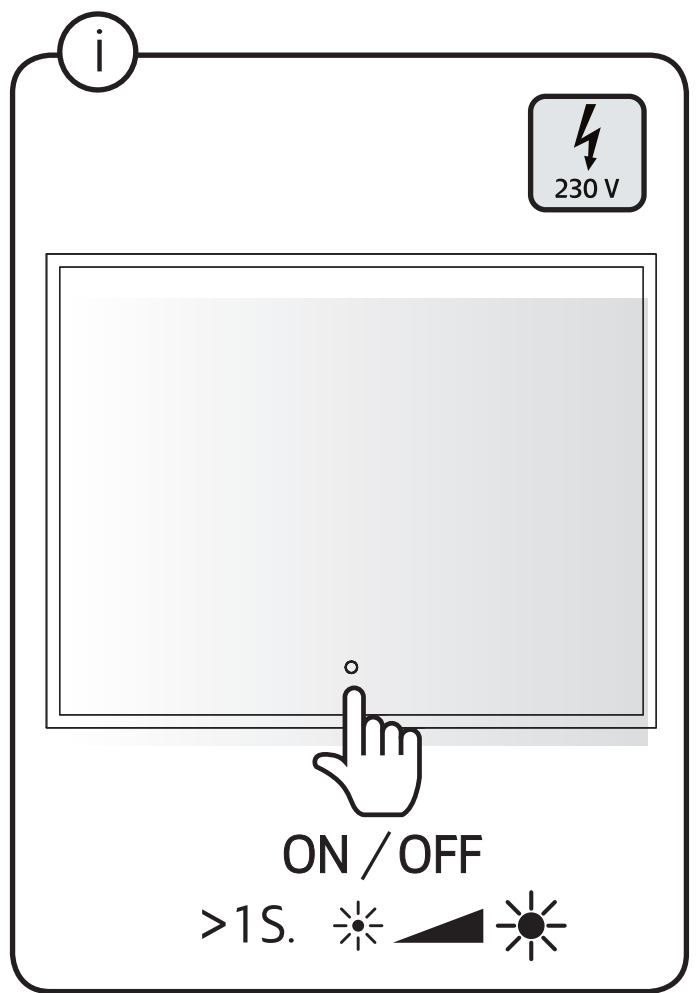
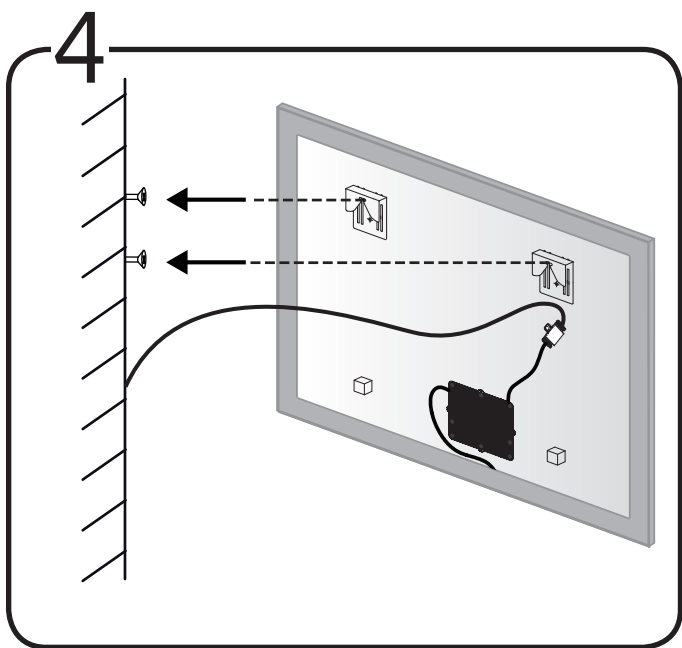
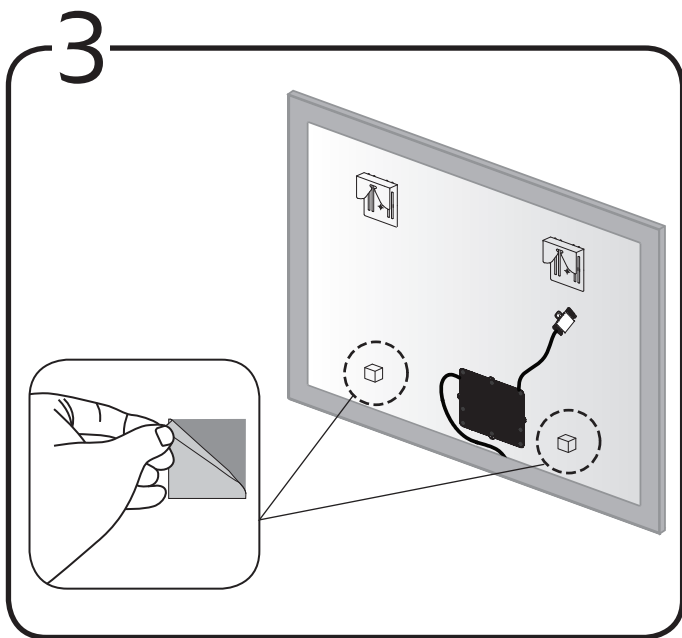

alt.

SE

Skruvinfästningar ska göras i betong eller annan massiv konstruktion, träreglar, träkortlingar eller i konstruktion som är provad och godkänd för infästning, till exempel skivkonstruktion. Se exempel på godkända konstruktioner på sakervatten.se. Material för tätning ska fästa mot underlaget och vara vattenbeständigt, mögelresistent och åldersbeständigt. Krav på tätning gäller både i våtzon 1 och 2.

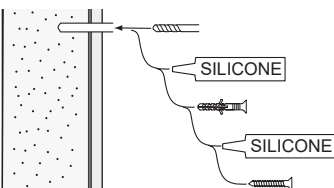

GB

Below are Swedish recommendations:
Screw fastenings should be made in concrete or other solid structure, wooden studs, wooden noggings or in structures that have been tested and approved for fastenings, for example a sheet construction. See examples of approved constructions at sakervatten.se. Sealing substances must fixate to the materials it aims to seal, be waterproof, mould-resistant and age-resistant. Requirements for sealing apply in wet zones 1 and 2.

Hafa[®]

Hafa
Svarvaregatan 5, Box 525
SE-301 80 Halmstad
SWEDEN

Garanti/Warranty.
Service, reservdelar/spare parts
Sweden: Tel: +46 (0)35 15 44 75
Norway: Tel: +47 (0)69 31 02 30
Finland: Puh: +358 (0)9 61500940

www.hafa.se
www.hafa.dk
www.hafabad.no
www.hafa.se
www.hafabathroom.ru
www.hafa.eu

E-mail:
service@hafa.se
service@hafabad.no